

Standard & Optional Equipment

SOLAR 255 LCV

Standard equipment

Hydraulic system

- Boom and arm flow regeneration
- Boom and arm holding valves
- Swing anti-rebound valves
- Spare ports (valve)
- One-touch power boost

Cabin & Interior

- Viscous cab mounts
- All weather sound suppressed type cab
- Air conditioner
- Adjustable suspension seat with head rest and adjustable arm rest
- Pull-up type front window and removable lower front window
- Room light
- Intermittent windshield wiper
- Cigarette lighter and ashtray
- Cup holder
- Hot & cool box
- Graphic display monitor
- Fuel control dial
- AM/FM Radio and cassette player
- Remote radio ON/OFF switch
- 12V spare power socket
- Serial communication port for laptop PC interface
- Joystick lever with 2 switches

Safety

- Large handrails and step
- Punched metal anti-slip plates
- Seat belt
- Hydraulic safety lock lever
- Safety glass
- Hammer for emergency escape
- Right and left rearview mirrors
- 360 degree fan guard

Others

- Double element air cleaner
- Pre-cleaner
- Water separator
- Dust screen for radiator
- Engine overheat prevention system
- Engine restart prevention system
- Self-diagnostic system
- Alternator (24V, 60 amps)
- Electric horn
- Halogen working lights (frame mounted 2, boom mounted 2)
- Hydraulic track adjuster
- Track guards

Optional equipment

Safety

- Boom and arm hose rupture protection valve
- Overload warning device
- Cabin Top/Front guard (ISO 10262, FOGS standard)
- Travel alarm
- Travel & swing alarm
- Rotating beacon

Cabin & Interior

- Sunvisor
- Sun roof
- Joystick lever with 3 switches

Others

- 2.99m narrow track
- Piping for hammer (one way)
- Piping for rotation
- Double fuel filter
- Greased and sealed track link
- Additional work lights on the cabin (① 2 front lamps, ② 4 front and 2 rear lamps)
- Large capacity alternator (24V, 80A)
- Electric fuel supply pump



Boom and arm hose rupture protection valve



Sunvisor



Additional work lights on the cabin



Electric fuel supply pump



Rotating beacon

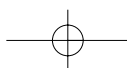

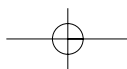

Seoul Office :
 Doosan Tower 27th FL. 18-12, Euljiro-6Ga,
 Jung-Gu, Seoul, Korea 100-730
 Tel : +82-2-3398-8114
 Fax : +82-2-3398-8117
www.doosaninfracore.com

Doosan Infracore Europe S.A.
 1A, Rue Achille Degrâce, 7080 Frameries, Belgium
 Tel : +32-65-61-3230 Fax : +32-65-67-7338

Doosan Infracore U.K., Ltd.
 Doosan House, Unit 6, 3 Heol Y Gamlas, Parc Nantgarw, Nantgarw,
 Cardiff. CF15 7QU, U.K.
 Tel : +44-1443-84-2273 Fax : +44-1443-84-1933

Doosan Infracore Europe S.A. Germany
 Heinrich-von-Stephan str. 2 40764 Langenfeld, Germany
 Tel : +49-2173-2035-210 Fax : +49-2173-2035-219

Doosan Infracore France
 ZAC de La Clef Saint Pierre - Buroplus 2 1A Avenue Jean d'Alembert
 78990 Elancourt, France
 Tel : +33-(0)1-30-16-21-41 Fax : +33-(0)1-30-16-21-44

Doosan Infracore America Corporation
 2905 Shawnee Industrial Way, Suwanee, Georgia 30024, U. S. A
 Tel : +1-770-831-2200 Fax : +1-770-831-0480

Doosan Infracore China Co., Ltd.
 #28, Wuzhishan Road, Eco. & Tech, Development Zone, Yantai, Shandong, China
 Tel : +86-535-638-2000 Fax : +86-535-638-2004

Doosan Infracore South Africa (PTY) LTD.
 60C Electron Road, Isando 1600, Johannesburg, South Africa
 Tel : 27-11-974-2095 Fax : 27-11-974-2778

Doosan Infracore Middle East Center (Dubai)
 P.O.Box 183127, Al-Serkal Building, Air Port Road, Dubai, U.A.E
 Tel : +971-4-295-2781~2 Fax : +971-4-295-2783

Doosan Infracore Latinamerica oficina (Colombia)
 Dia gonal 127 A No. 17-14, oficina 302 Bogota, Colombia
 Tel : +571-216-1655 Fax : +571-648-7700



PBP S255C500 0701

The illustrations do not necessary show the product in standard version.
 All products and equipments are not available in all markets.
 Materials and specifications are subjects to change without prior notice.

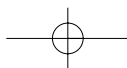

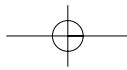

Doosan Infracore
Construction Equipment

SOLAR255LCV

Engine Power : DIN 6271,net 121kw(165ps)@2,000 rpm
 SAE J 1349,net 121kw(162HP)@2,000 rpm
Operational Weight : 24,600kg (54,200 lb)
Bucket capacity(PCSA) : 1.1m³(1.44 cu.yd)



Performance

This hydraulic excavator is equipped with the air-to-air intercooler engine, which has the greatest power output in its class and excellent fuel economy. It assures outstanding workability, productivity, and efficiency through the e-EPOS system, the new and improved version of EPOS System. This will assure increase in operating capacity and decrease in fuel consumption.

Improved maneuverability and control

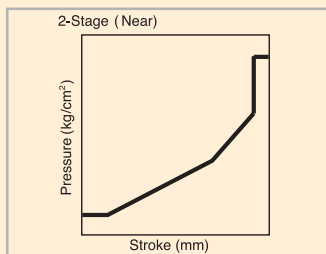

New technologically advanced control valve and joystick valves have been installed to allow speedy, smooth and responsive control.

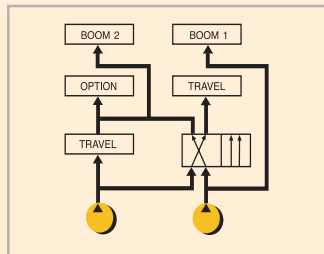

Advanced hydraulic circuit separates the oil flow for travel and boom function to allow precise and safe operation when handling loads during travel.

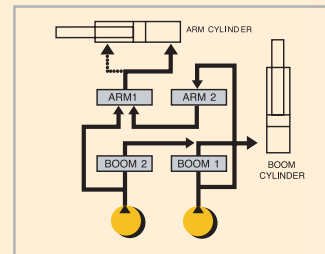

The circuits for the boom, arm, and bucket have been improved to assure smooth and confident control during combination.

Air to Air Intercooler Engine

Greatest power output and high-efficiency engine in it's class.

Environment friendly, Green engine.

This machine is equipped with the engine meeting the U.S. EPA Tier-II Regulations and European stage-II Regulations requiring the reduction of harmful NOx, PM, HC, and CO emissions.

Compatible with the European New Noise Control Requirements



Joystick grip with 2 switches
Spare switches are installed on both joystick grips to control the additional attachment.

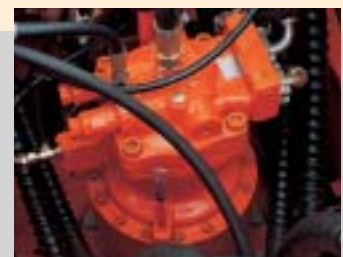

Improved swing mechanism.
(Equipped with anti-rebound valve)
Swing anti-rebound valve is installed as standard equipment, which allows the operator to stop the upper structure at the desired position. As a result, operating efficiency has been greatly improved.

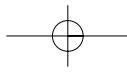

Excellent Reliability

Doosan's world-class center for product reliability performs sophisticated testing on all completed products, to ensure they meet or exceed market standards.



360° fan guard

A metal mesh guard has been installed all around the fan blade to prevent accidental bodily injury.



Emergency throttle cable
In the event of engine speed control dial malfunction, emergency throttle cable mounted in the cabin can be used to manually control engine speed.



Rubber coated wire harness clamps
Electric wire harnesses have been mounted with rubber coated clamps to decrease vibration damage.



Rubber pipe clamps
Improved material pipe clamps have been installed. This has resulted in noise reduction, increased vibration absorption and durability characteristics as well as preventing pipe cracks.

Heat shield panel for turbo charger
The heat shield guard has been installed over the turbo charger to prevent the operator from inadvertently touching the hot surfaces while checking the engine area.

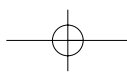

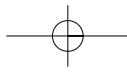

Working Environment

Wide operator cabin space meet the ISO Standards and expanded all-round visibility. The low-noise, low-vibration type comfortable cabin provides the operator with safe and ergonomic operating environment.



Good visibility

The enlarged right-hand glass and the minimized crosswise strut in windshield have been achieved to increase the visual range by 15% when compared to the previous machine.



Increased foot space

Instruments, controls, and accessories have been ergonomically located in the cabin and 300mm seat slide has been achieved to provide ample space for operator's feet and legs.



Long wind shield wiper blade

Front visibility is further improved by using the lengthened wiper blade (wiper area increased 35% compared to previous machine.)

Large ceiling cover

The ceiling cover can be opened to confirm the bucket operation even at the maximum excavating height. (Visual range increased by 25% compared to previous machine.)

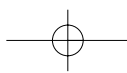

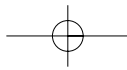

Cup holder

A folding style cup holder has been installed in the cabin allowing the operator to easily store a can or cup.



12V Spare Power Socket

This socket can be used for charging a cellular phone or powering a small 12V DC electrical device.

Fresh Air Type Air Conditioner

One touch selector switch for the air conditioner and heater output, featuring a multi-vent circulation system that allows for greater cooling / heating performance. Improved front window defroster system has been added to provide enhanced clarity and visibility during any working condition.

- Easy replaceable air filter.
- Larger cool air intake vents.
- Industry standard fresh air/recirculation control system incorporated.
- Modular electric fan condenser compartment.

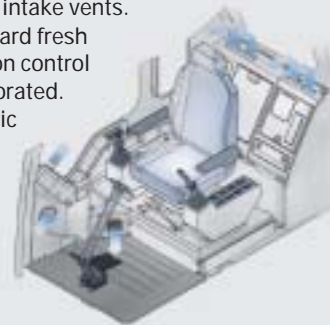

Low Vibration Cab Mounting System

By using a total isolating seal design (full sealing) outside noise has been drastically reduced to the levels comparable to that in a modern car. A viscous sealed mounting system has been incorporated, and the frame, cabin and seat have been designed to absorb major and minor vibrations, resulting in a significant decrease in vibration felt by the operator.

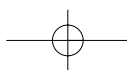
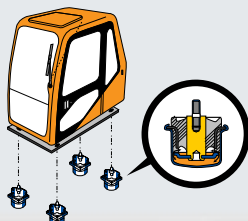

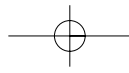

Maintenance

Quick and easy service checks, maximizing the excavator's life expectancy.

PC monitoring function (SMS)

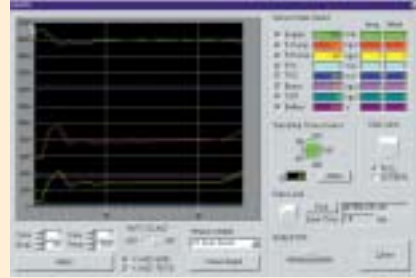

By connecting a laptop PC to the controller (e-EPOS controller) of the machine, data such as pump pressure and engine RPM can be displayed graphically. Also other various machine status data can be stored in memory and printed out using a printer.



electrical control access box
Pull-out style drawer for electrical control access box allows for easy service and maintenance.



Engine oil drain valve
The engine oil drain valve with quick coupler provides fast and environmentally sound serviceability.



Water separator
The transparent glass water separator is mounted at a location easily accessible from the ground allowing easy maintenance of the fuel system.



Easy radiator cleaning
The clearance between the oil cooler and radiator has been widened for easy insertion of the air nozzle during cleaning.



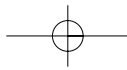

Graphic display LCD Monitor panel

The information monitor panel displays both text and symbols for easy recognition of machine status and various other data



Simplified operation mode selection

The 3 work modes from the previous models have been reduced to digging and trenching modes for easy selection.

- Digging Mode :
General Excavating, Ground Leveling, Loading Dump Truck, allows for versatility.
- Trenching Mode :
trenching or excavating of side wall, operations which require heavy swing work.

FAILURE LOG
CODE: 12 N:001 0075Hr
Press up s/v open
PRV:▲ NXT:▼ 01/01

Self-diagnosis and fault history memory functions

Current faults and past faults history of the excavator control system are displayed and memorized on a real-time basis to enable correct diagnosis and quick repair.



02/05 [MO] 11:30A
ENG SPEED
2059
RPM

Real-time clock with day / date

The real-time clock displays date and day in easy to read format.

1. Fuel Filter
Hrs: 0232 Reset

Filter / oil operating hour display

The hours in use for 9 filters and oils can be displayed so that replacement intervals can be easily recognized.

LANGUAGE
Francais
Deutsch 4
SET: English

Multiple language display

The user menu can be displayed in multiple languages for the operator's convenience.

EPPR CURRENT
598
mA

Real-time machine data display

Displays 28 different machine status data and information such as pump delivery pressure and engine RPM.

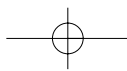

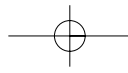

Technical Data

Engine

Model	DOOSAN DB58TIS
Type	Water-cooled, 4-cycle, direct injection .
Aspiration	Turbocharged Air-to-Air intercooled
No. of cylinders	6
Rated flywheel horse power	
DIN 6271, net	121KW (165PS) at 2,000 rpm
SAE J1349, net	121KW (162HP) at 2,000 rpm
Piston displacement	5,785cc (353cu.in)
Maximum torque	68kgf.m (666Nm, 492 lbf.ft) @ 1,400 rpm
Bore and stroke	102mm × 118mm (4.0" × 4.6")
Starting system.....	24V Electric motor
Batteries	2 × 12V × 100 AH

Hydraulic system

e-EPOS (Electronic Power Optimizing System) allows the operator to maximize work efficiency over a full range of operating conditions and to minimize fuel consumption.

- Hydraulic system assures fully independent and combined operations.
- Automatic 2 speed travel system for high traction force and travel speed.
- Cross-sensing and fuel saving pump system.
- Auto idle system.
- 2-Working /2-power mode selection system.
- Computer aided engine-pump control.

Main pumps	2 variable displacement axial piston pumps.
Max. oil flow	2 × 224 l/min (2 × 59.2 US gpm, 2 × 49.3 Imp gpm)
Pilot pump	Gear pump
Max. oil flow	30 l/min (7.9US gpm, 6.6 Imp gpm)
Swing motor	
Relief valve	279bar (4,050 psi, 285kgf/cm ²)

Main relief valves

Boom/Arm/Bucket	Normal : 324bar (4,690 psi, 330kgf/cm ²) Power Boost : 343bar (4,980 psi, 350kgf/cm ²)
Travel circuit	324bar (4,690 psi, 330kgf/cm ²)

Hydraulic cylinders

High-strength piston rods and tubes are used. Cylinder cushion mechanism is provided for all cylinders to assure shock-free operation and extend life of cylinder.

Cylinders	Q'ty	Bore × Rod dia. × Stroke
Boom	2	130 × 90 × 1,320mm (5.1" × 3.5" × 52.0")
Arm	1	140 × 100 × 1,705mm (5.5" × 3.9" × 67.1")
Bucket	1	130 × 90 × 1,050mm (5.1" × 3.5" × 41.3")

Super-structure revolving frame

A deep, full-reinforced box section. Heavy-gauge steel plates used for ruggedness.

Operator's cab

A roomy, independent, shock and noise-free operator's cab, 4 side safety glass windows give all-round visibility. Front window slides up and stores in the roof and side window can be opened for ventilation. Fully adjustable suspension seat. Air conditioner. ISO standard cab.

Noise Levels (dynamic value)

L _{WA} External noise	
Guaranteed Sound Power Level	105 dB (A) (2000/14/EC)
Measured Sound Power Level	104 dB (A) (2000/14/EC)
L _{PA} Operator noise	74 dB (A) (ISO 6396)

Controls. 2 implement levers

Pilot pressure control type. Right lever is boom and bucket control, left lever for swing and arm control.

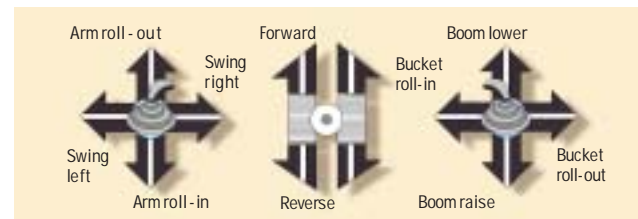

2 Travel pedals with levers

Pilot pressure control type. Independent drive at each track allows counter-rotation of the tracks. Levers are detachable.

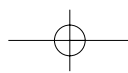

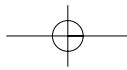

Swing mechanism

High-torque, axial piston motor with planetary reduction gear bathed in oil. Swing circle is singlerow, shear type ball bearing with induction-hardened internal gear. Internal gear and pinion gear immersed in lubricant. Swing parking brake is spring-set, hydraulic-released disc type.

- Swing speed 0 to 10.9 rpm(min⁻¹)
- Rear swing radius 3,035 mm(9'11")



Drive

Each track is driven by an independent, high-torque, axial piston motor through planetary reduction gear. Two levers or foot pedal control provide smooth travel or counter-rotation upon demand.

Travel speed (High/Low) 5.0/3.5 km/h
(3.1/2.1 mph)

Maximum traction force 21,100 kgf (46,520 lbf)

Gradeability 35° (70%) continuous



Undercarriage

Tractor type undercarriage. Heavy-duty track frame, all welded stress-relieved structure. Top grade materials are used for toughness. Side frames are welded, securely and rigidly, to the track frame. Lifetime-lubricated track rollers, idlers and sprockets with floating seals. Track shoes of induction-hardened rolled alloy with triple grousers. Specially heart-treated connecting pins. Hydraulic track adjusters with shock-absorbing recoil springs.

Number of rollers and shoes (each side) ground contact area

Upper rollers 2

(Standard shoe)

Lower rollers 10

Track shoes 51

Overall track length 4,635mm(15'2")



Brake

Two oil disc brake on final drive input shafts. Parking brake is spring-set, hydraulic-released disc type.



Weight

Equipped with 5.9m(19'4") boom, 3.0m(9'10") arm, and 1.1m³(1.44yd³; PCSA heaped) bucket and 600mm(24") shoes.

Shoe type	Shoe width	Operating weight	Ground pressure
Triple grouser	600mm (24")	24,600kg (54,200lb)	0.49kgf/cm ² (48kpa, 7.0psi)
	700mm (28")	24,900kg (54,900lb)	0.43kgf/cm ² (42kpa, 6.1psi)
	800mm (32")	25,200kg (55,600lb)	0.38kgf/cm ² (37kpa, 5.4psi)
	900mm (36")	25,500kg (56,200lb)	0.34kgf/cm ² (33kpa, 4.8psi)



Service refill capacities

	Liters	US gal	Imp gal
Fuel tank	370	97.8	81.4
Cooling system	36	9.5	7.9
Lubrication	Liters	US gal	Imp gal
Engine oil	19	5.0	4.2
Swing drive(each)	11	2.9	2.4
Final drive(each)	5	1.3	1.1
Hydraulic system	290	76.6	63.4
Hydraulic tank	155	40.9	53.8

Buckets

Capacity		Width		Weight	Recommendation			
PCSA, heaped	CECE, heaped	Without side cutters	With side cutters		2.0m (6'7")Arm	2.5m (8'2")Arm	3.0m (9'10")Arm	3.5m (11'6")Arm
0.5m ³ (0.65yd ³)	0.45m ³	688mm (27")	778mm (31")	530kg (1,800 lb)	A	A	A	A
0.81m ³ (1.06yd ³)	0.7m ³	1,058mm (42")	1,168mm (51")	690kg (1,520 lb)	A	A	A	A
0.93m ³ (1.22yd ³)	0.8m ³	1,180mm (46")	1,290mm (51")	730kg (1,610 lb)	A	A	A	A
1.05m ³ (1.37yd ³)	0.9m ³	1,302mm (51")	1,412mm (56")	790kg (1,740 lb)	A	A	A	B
1.1m ³ (1.44yd ³)	0.95m ³	1,260mm (50")	1,370mm (54")	815kg (1,800 lb)	A	A	A	C
1.17m ³ (1.53yd ³)	1.0m ³	1,428mm (56")	1,538mm (61")	830kg (1,830 lb)	A	A	B	C
1.29m ³ (1.69yd ³)	1.1m ³	1,560mm (61")	1,670mm (66")	885kg (1,950 lb)	A	A	B	C

A. Suitable for materials with density of 2,000 kg/m³ (3,370 lb / cu-yd) or less
 B. Suitable for materials with density of 1,600 kg/m³ (2,700 lb / cu-yd) or less
 C. Suitable for materials with density of 1,100 kg/m³ (1,850 lb / cu-yd) or less

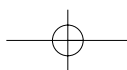

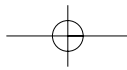

Dimensions & Working Ranges

Dimensions (5.9m(19' 4") Boom, 3.0m(9' 10") Arm, 600mm(24") Shoe)

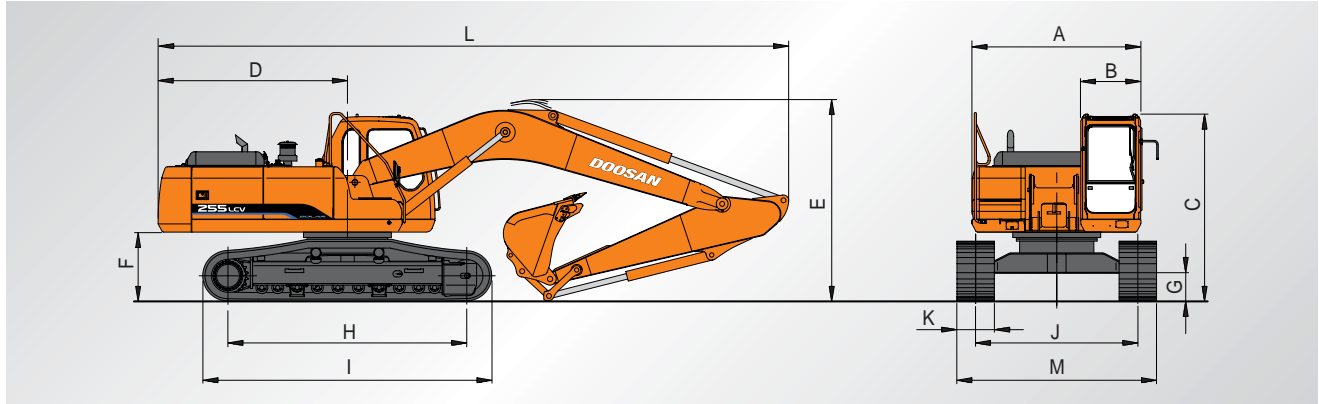

A Overall width of upper structure	2,710mm(8'11")
B Overall width of cab	960mm(38")
C Overall height of cab	3,000mm(9'10")
D Tail swing radius	3,035mm(9'11")
E Overall height	3,250mm(10'8")
F Clearance under counterweight	1,110mm(3'8")
G Ground clearance	450mm(18")
H Tumbler distance	3,830mm(12'7")
I Track length	4,635mm(15'2")
J Track gauge (standard track)	2,600mm(8'6")
J' Track gauge (narrow track)	2,390mm(7'10")
K Track shoe width	600mm(24")
L Overall length	10,110mm(33'2")
M Overall track width (standard track)	3,200mm(10'6")
M' Overall track width (narrow track)	2,990mm(9'10")

Working ranges

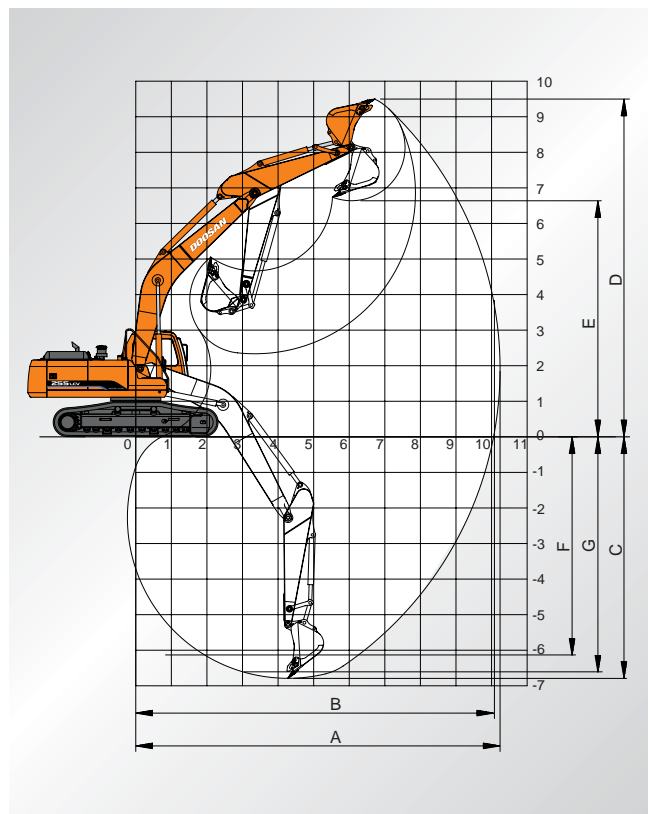

Digging forces (Maximum radial tooth forces)

	3.0m (9'10")Arm	2.5m (8' 2")Arm	3.5m (11' 6")Arm
Bucket digging force *	15,200 kgf	15,200 kgf	15,200 kgf
	149 kN	149 kN	149 kN
	33,500 lbf	33,500 lbf	33,500 lbf
Arm digging force *	11,800 kgf	13,800 kgf	10,700 kgf
	116 kN	135 kN	109 kN
	26,000 lbf	30,250 lbf	24,400 lbf

*At power boost

Boom length	5,900mm (19'4")		
Arm length	3.0m (9'10") Arm	2.5m (8'2") Arm	3.5m (11'6") Arm
A. Max. digging reach	10,240mm (33'7")	9,740mm (31' 4")	10,710mm (35' 2")
B. Max. digging reach at ground level	10,060mm (33')	9,560mm (31' 11")	10,540mm (34' 7")
C. Max. digging depth	6,790mm (22'3")	6,290mm (20' 8")	7,290mm (23' 11")
D. Max. digging height	9,500mm (31'2")	9,180mm (30' 1")	9,720mm (31' 11")
E. Max. dumping height	6,640mm (21'9")	6,360mm (20' 10")	6,860mm (22' 6")
F. Max. vertical wall digging depth	6,080mm (19'11")	5,360mm (17'7")	6,560mm (21'6")
G. Max. digging depth (8' level)	6,620mm (21'9")	6,090mm (19' 12")	7,140mm (23' 5")

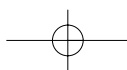

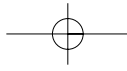

Lifting Capacities

Standard

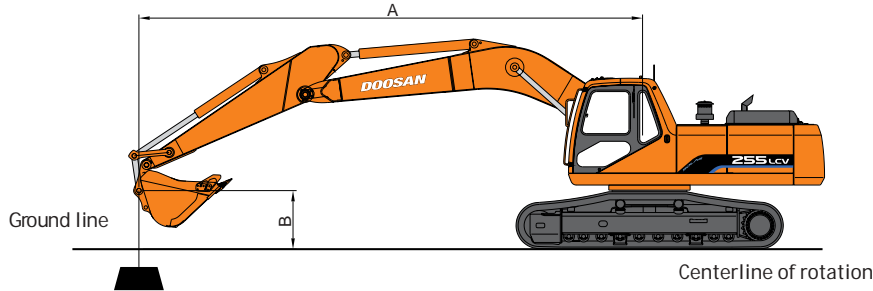

Boom : 5.9m (19'4")
 Arm : 3.0m (9'10")
 Bucket : PCSA 1.1m³ (CECE 0.95m³)
 Shoe : 600mm (24")

Metric

Unit : 1,000 kg

A (m)	2		3		4		5		6		7		8		Max. Reach			
	☺	☻	☺	☻	☺	☻	☺	☻	☺	☻	☺	☻	☺	☻	☺	☻	A (m)	
7												*4.46	*4.46			*3.60	*3.60	7.33
6												*5.03	*5.03			*3.61	*3.61	7.94
5												*5.30	5.01	*4.94	3.99	*3.68	3.67	8.39
4										*6.16	*6.16	*5.71	4.92	*5.43	3.94	*3.81	3.41	8.70
3			*14.32	*14.32	*10.07	*10.07	*8.07	*8.07	*6.93	6.12	*6.21	4.81	*5.74	3.87	*4.00	3.25	8.88	
2			*6.75	*6.75	*12.07	11.10	*9.28	7.84	*7.71	5.94	*6.72	4.69	5.79	3.80	*4.26	3.17	8.95	
1			*5.86	*5.86	*13.51	10.73	*10.29	7.60	*8.40	5.79	7.04	4.59	5.72	3.74	*4.61	3.16	8.90	
0(Ground)			*7.18	*7.18	*14.28	10.52	*10.97	7.44	8.86	5.67	6.95	4.51	5.66	3.69	4.94	3.22	8.74	
-1	*6.21	*6.21	*9.31	*9.31	*14.50	10.43	*11.31	7.35	8.78	5.60	6.90	4.46	5.63	3.66	5.18	3.37	8.46	
-2	*8.78	*8.78	*12.00	*12.00	*14.28	10.43	*11.29	7.32	8.75	5.57	6.88	4.44	5.63	3.66	5.59	3.63	8.04	
-3	*11.60	*11.60	*15.36	*15.36	*13.63	10.49	*10.91	7.35	8.77	5.58	6.90	4.46			6.28	4.08	7.46	
-4	*14.93	*14.93	*15.90	*15.90	*12.47	10.61	*10.05	7.43	*8.19	5.65					*7.04	4.84	6.68	
-5			*13.29	*13.29	*10.56	*10.56	*8.44	7.58							*7.24	6.38	5.62	

Feet

Unit : 1,000 lb

A (ft)	10'		15'		20'		25'		Max. Reach			
	☺	☻	☺	☻	☺	☻	☺	☻	☺	☻	A (ft)	
25'									*8.02	*8.02	22'48"	
20'								*9.76	9.66	*7.95	*7.95	25'89"
15'					*12.62	*12.62	*11.78	9.52	*8.23	7.81	28'01"	
10'	*30.44	*30.44	*19.19	*19.19	*15.01	13.19	*12.95	9.26	*8.80	7.18	29'11"	
5'	*13.84	*13.84	*23.98	19.51	*17.47	12.62	13.69	8.97	*9.73	6.95	29'33"	
0(Ground)	*16.40	*16.40	*26.87	18.80	19.05	12.21	13.45	8.75	10.90	7.10	28'67"	
-5'	*23.98	*23.98	*27.59	18.55	18.83	12.01	13.33	8.65	11.84	7.70	27'08"	
-10'	*34.86	*34.86	*26.28	18.63	18.85	12.03			13.94	9.05	24'36"	
-15'	*31.68	*31.68	*22.37	19.01	*15.89	12.33			*15.81	12.28	20'06"	

- Note 1. Ratings are based on SAE J1097
 2. The load point is a hook located on the back of the bucket.
 3. *Rated loads are based on hydraulic capacity.
 4. Rated loads do not exceed 87% of hyd. capacity or 75% of tipping capacity.

- ☺ : Rating over front
 ☻ : Rating over side or 360 degree
 O : Ground

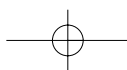

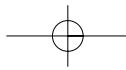

Option

Metric

Boom : 5.9m (19'4") Arm : 2.5m (8' 2") Bucket : PCSA 1.29m³(CECE 1.1m³) Shoe : 600mm (24") Unit : 1,000kg

B (m)	A (m)		2		3		4		5		6		7		8		Max. Reach			
	□	□	□	□	□	□	□	□	□	□	□	□	□	□	□	□	□	□	A (m)	
7																		*4.88	*4.88	6.65
6												*5.46	4.94					*4.91	4.56	7.32
5										*5.96	*5.96	*5.68	4.88					*5.04	4.05	7.80
4								*7.48	*7.48	*6.60	6.16	*6.05	4.80	*5.73	3.83			*5.26	3.73	8.13
3					*11.10	*11.10	*8.67	7.95	*7.32	5.98	*6.50	4.70	5.76	3.78				5.39	3.53	8.33
2					*12.90	10.82	*9.78	7.67	*8.04	5.82	*6.96	4.59	5.70	3.72				5.27	3.43	8.40
1					*14.00	10.53	*10.63	7.47	*8.64	5.68	6.95	4.50	5.64	3.66				5.27	3.42	8.35
0(Ground)			*6.84	*6.84	*14.42	10.40	*11.14	7.34	8.78	5.59	6.88	4.44	5.60	3.63				5.41	3.51	8.18
-1	*6.88	*6.88	*10.06	*10.06	*14.35	10.37	*11.29	7.28	8.72	5.53	6.84	4.40						5.72	3.70	7.87
-2	*10.27	*10.27	*13.71	*13.71	*13.88	10.41	*11.09	7.28	8.71	5.53	6.85	4.40						6.27	4.05	7.42
-3	*13.90	*13.90	*16.43	*16.43	*12.97	10.50	*10.48	7.34	*8.58	5.57								7.23	4.65	6.79
-4	*18.26	*18.26	*14.36	*14.36	*11.50	10.66	*9.31	7.45										*7.57	5.78	5.92
-5					*9.05	*9.05												*7.66	*7.66	4.69

Feet

Unit : 1,000 lb

B (ft)	A (ft)		10'		15'		20'		25'		Max. Reach			
	□	□	□	□	□	□	□	□	□	□	□	□	A (ft)	
20'												*10.81	10.2	23'83"
15'							*13.60	13.42	*12.50	9.26		*11.30	8.58	26'12"
10'					*20.82	20.19	*15.86	12.89	*13.51	9.04		11.91	7.80	27'30"
5'					*25.12	19.10	*18.09	12.37	13.50	8.79		11.58	7.54	27'53"
0(Ground)	*15.67	*15.67	*27.25	18.55	18.86	12.03	13.30	8.61	11.93	7.73		7.73		26'83"
-5'	*26.76	*26.76	*27.23	18.44	18.72	11.90	13.26	8.57	13.16	8.51		8.51		25'12"
-10'	*35.61	*35.61	*25.16	18.62	*18.49	12.00			16.07	10.34				22'16"
-15'	*27.79	*27.79	*19.98	19.14					*16.89	15.36				17'31"

Metric

Boom : 5.9m (19'4") Arm : 3.5m (11' 6") Bucket : PCSA 0.93m³(CECE 0.8m³) Shoe : 600mm (24") Unit : 1,000kg

B (m)	A (m)		2		3		4		5		6		7		8		9		Max. Reach				
	□	□	□	□	□	□	□	□	□	□	□	□	□	□	□	□	□	□	□	□	A (m)		
7																					*3.09	*3.09	7.88
6													*4.13	4.09							*3.09	*3.09	8.45
5												*4.89	*4.89	*4.84	4.05						*3.14	*3.14	8.87
4												*5.32	4.97	*5.10	3.98	*3.79	3.25				*3.23	3.14	9.16
3							*7.40	*7.40	*6.45	6.18	*5.84	4.85	*5.44	3.90	*4.55	3.20					*3.37	3.00	9.34
2					*10.95	*10.95	*11.12	*11.12	*8.68	7.92	*7.28	5.99	*6.39	4.72	*5.80	3.82	4.81	3.15			*3.56	2.93	9.40
1					*7.29	*7.29	*12.81	10.81	*9.80	7.65	*8.04	5.81	*6.91	4.60	5.72	3.74	4.76	3.10			*3.82	2.91	9.36
0(Ground)	*3.85	*3.85	*7.57	*7.57	*13.88	10.53	*10.63	7.45	*8.65	5.67	6.95	4.50	5.65	3.68	4.72	3.07				*4.17	2.96	9.20	
-1	*5.82	*5.82	*9.03	*9.03	*14.37	10.39	*11.13	7.32	8.76	5.57	6.88	4.44	5.61	3.63						*4.65	3.08	8.93	
-2	*7.93	*7.93	*11.13	*11.13	*14.38	10.34	*11.28	7.27	8.70	5.52	6.84	4.40	5.59	3.62						5.07	3.29	8.54	
-3	*10.31	*10.31	*13.85	*13.85	*13.96	10.37	*11.08	7.27	8.70	5.52	6.84	4.40								5.61	3.64	8.00	
-4	*13.10	*13.10	*16.94	*16.94	*13.06	10.46	*10.46	7.32	*8.56	5.56	6.89	4.45								6.51	4.21	7.28	
-5	*16.60	*16.60	*14.74	*14.74	*11.53	10.62	*9.26	7.44	*7.42	5.67										*6.85	5.27	6.32	
-6			*11.38	*11.38	*8.96	*8.96															*6.96	*6.96	4.98

Feet

Unit : 1,000 lb

B (ft)	A (ft)		10'		15'		20'		25'		30'		Max. Reach									
	□	□	□	□	□	□	□	□	□	□	□	□	□	□	A (ft)							
25'															*6.88	*6.88	24'39"					
20'									*10.07	9.82					*6.80	*6.80	27'57"					
15'									*10.97	9.63					*6.99	*6.99	29'56"					
10'					*17.41	*17.41	*13.98	13.32	*12.24	9.33	*8.96	6.87	*7.41	6.63						*7.41	6.63	30'61"
5'	*19.37	*19.37	*22.54	19.69	*16.62	12.69	*13.67	9.00	10.28	6.72	*8.10	6.42	*8.10	6.42						*8.10	6.42	30'82"
0(Ground)	*17.29	*17.29	*26.05	18.82	*18.74	12.21	13.44	8.74	*9.94	6.59	*9.19	6.53	*9.19	6.53						*9.19	6.53	30'19"
-5'	*22.66	*22.66	*27.43	18.43	18.75	11.93	13.27	8.58					10.80	7.00						10.80	7.00	28'68"
-10'	*31.42	*31.42	*26.79	18.42	18.70	11.89	13.28	8.59					12.44	8.07						12.44	8.07	26'14"
-15'	*34.36	*34.36	*23.82	18.70	*17.32	12.09							*14.87	10.42						*14.87	10.42	22'19"
-20'			*16.43	*16.43									*15.32	*15.32						*15.32	*15.32	15'81"

Note 1. Ratings are based on SAE J1097

2. The load point is a hook located on the back of the bucket.

3. *Rated loads are based on hydraulic capacity.

4. Rated loads do not exceed 87% of hyd. capacity or 75% of tipping capacity.

□ : Rating over front

□ : Rating over side or 360 degree

0 : Ground

